

# GASPARDO

MOD. **SP DORADA**  
**SARA**  
**ST STELLA**  
**SI SIMONA**  
**SILVIA**



Seminatrici pneumatiche di precisione per varie colture su terreni lavorati.



Semoirs pneumatiques de précision pour différentes cultures sur terrains préparés.



Pneumatic precision planters for various cultivations on tilled soil.



L'elemento seminatore SP, risultato dello sviluppo decennale di Gaspardo, è indicato per la semina di precisione su terreni lavorati. Semplicità d'utilizzo, affidabilità e precisione di distribuzione sono le principali caratteristiche. Sono disponibili molteplici configurazioni dell'elemento e vari telai (fissi, telescopici e pieghevoli) per adattarsi a diverse colture ed esigenze.

Questo elemento è indicato per terreni lavorati in assenza, o con quantitativi limitati, di residui colturali in superficie. Il solco di deposizione è creato da un falciatore mentre la profondità di semina viene regolata tramite il sistema a parallelogramma tra telaio e ruota posteriore, registrabile tramite il martinetto meccanico. La pressione al suolo dell'elemento è variabile per mezzo della molla di carico.



The SP seeding unit for precision seeding on tilled soil is the result of years of experience and development by Gaspardo. The SP seeding unit is easy to use, constantly reliable and highly accurate. The unit is available in a number of configurations and with different kinds of frames (fixed, telescoping or folding) to meet the various requirements of different crops.

The unit is especially recommended for sowing on tilled soils without crop residues on the ground. The seeding furrow is made by a drill coulter and the seeding depth is set by a parallelogram system between the frame and the rear wheel, which can be adjusted by a mechanical jack. The pressure applied by the seeding unit on the ground is controlled by a spring.



L'élément semeur SP, issu de dix ans de recherche et d'étude de Gaspardo, est parfaitement indiqué pour l'ensemencement de précision sur terrains préparés. Sa simplicité d'utilisation, sa fiabilité et sa précision dans la distribution sont ses principales caractéristiques. L'élément est disponible en de nombreuses configurations et avec différents châssis (fixes, télescopiques et pliants) afin de s'adapter aux différentes cultures et aux exigences les plus variées. Cet élément est recommandé pour les terrains préparés présentant peu de résidus de cultures en surface. Le sillon de semis est créé par un soc tandis que la profondeur du semis est réglée à l'aide d'un système à parallélogramme placé entre le châssis et la roue arrière, réglable à l'aide de vérins pneumatiques ou bien mécaniquement. La pression exercée sur le sol par l'élément varie en fonction du réglage de la compression du ressort.

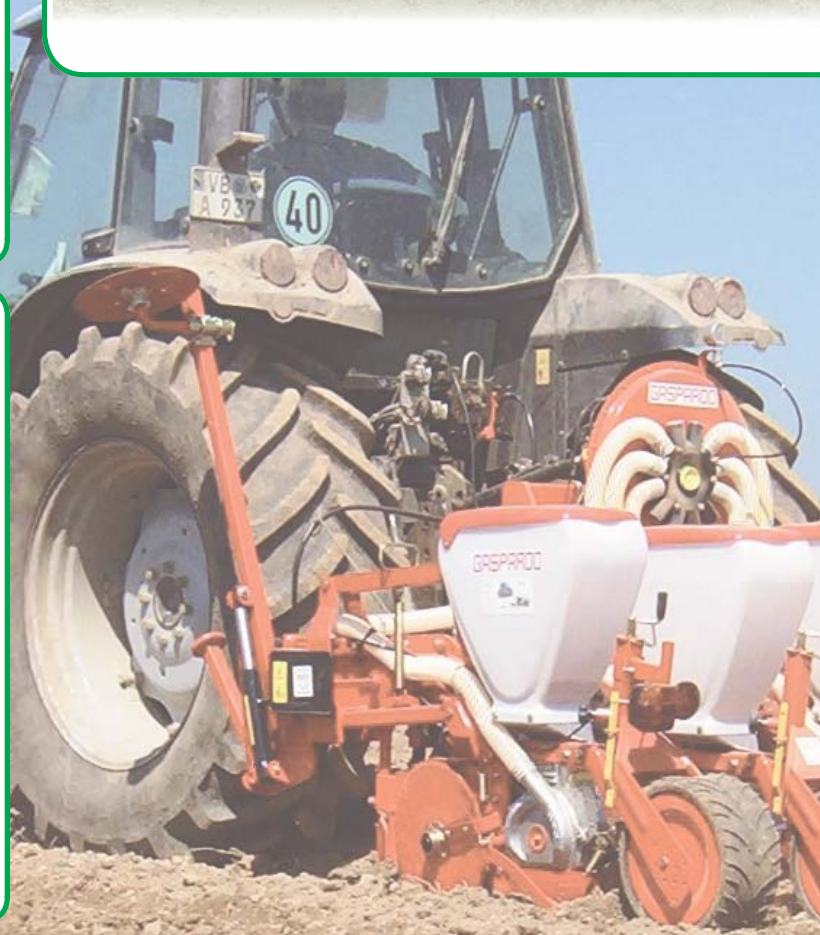
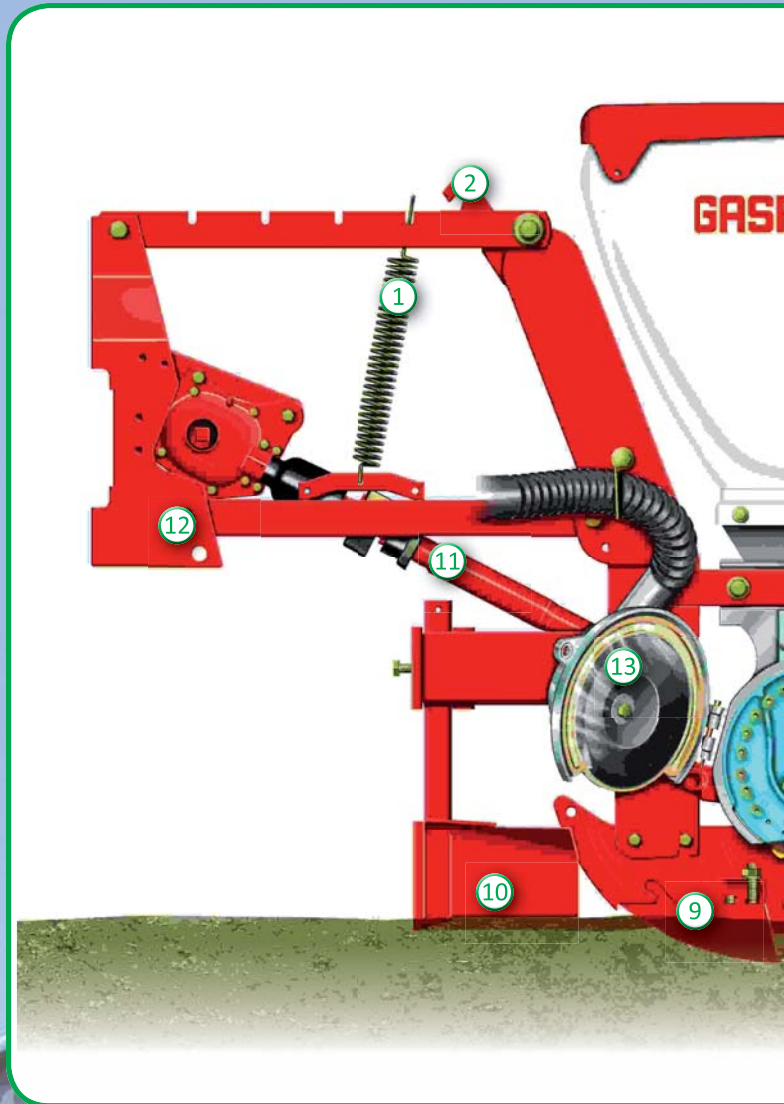

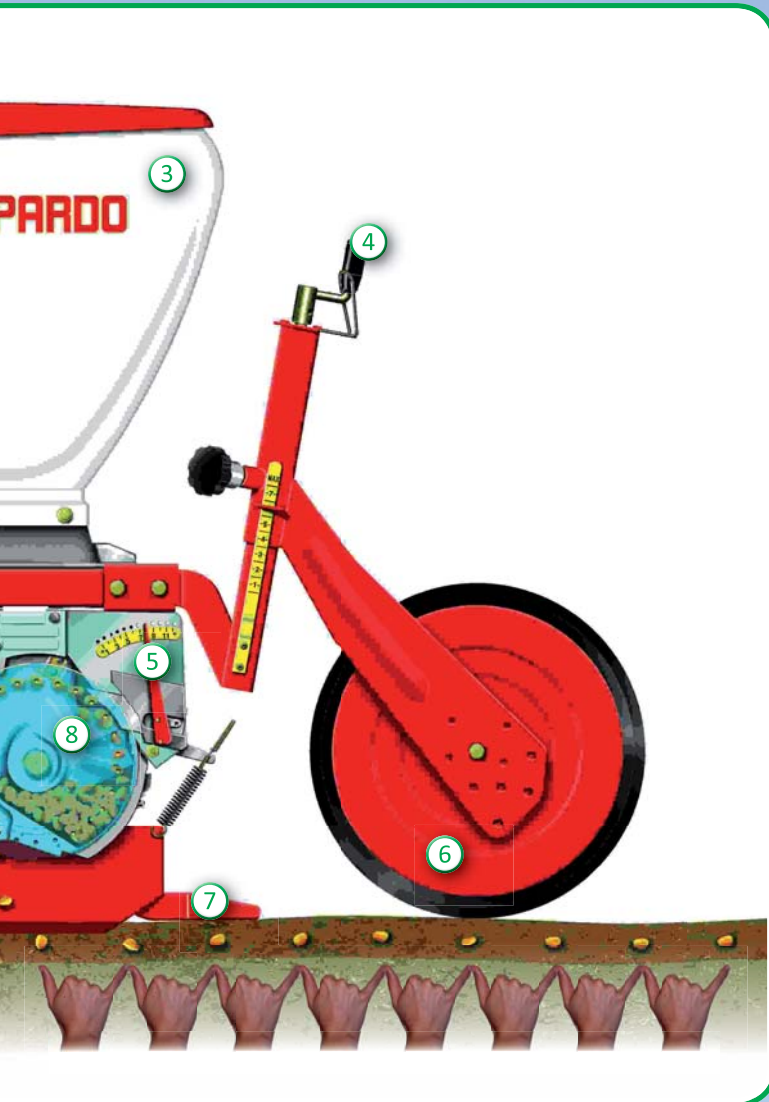

## PUNTI DI FORZA

- 1 Molla di pressione e/o alleggerimento
- 2 Sgancio rapido dell'elemento
- 3 Tramoggia in plastica - 34 l
- 4 Regolazione della profondità di semina precisa e senza scatti
- 5 Selettore seme in acciaio
- 6 Ruota posteriore di compressione (farmflex, in gomma Ø 370, a "V" in gomma da 2", a "V" in gomma da 1")
- 7 Elementi coprisolco per assicurare la chiusura del solco di semina
- 8 Corpo distributore completamente in alluminio
- 9 Falcione in acciaio antiusura con sistema di sostituzione rapida
- 10 Spartizolle regolabile
- 11 Affidabile trasmissione a cardano con disinnesto rapido e sicurezza acustica: manutenzione zero
- 12 Boccole sinterizzate autolubrificanti: manutenzione zero
- 13 Apertura rapida per una facile sostituzione del disco, guarnizione a basso attrito

## STRONG POINTS

- 1 Pressure and/or relief spring
- 2 Quick release system
- 3 Plastic hopper - capacity 34 l
- 4 Seeding depth adjustment precise and linear
- 5 Stainless steel double eliminator
- 6 Rear press wheel (Ø 370 rubber Farmflex wheel, 2" rubber V-wheel, 1" rubber V-wheel)
- 7 Furrow closing device
- 8 Cast aluminium body
- 9 Steel drill coulter with fast replacement system
- 10 Adjustable bed leveler
- 11 Reliable quick-release cardan drive with acoustic warning: maintenance free
- 12 Self-lubricating sinterized bushings: maintenance free
- 13 Opens easily to facilitate disc replacement, low-friction seal

## ATOUTS

- 1 Ressort de pression et/ou d'allègement
- 2 Décrochage rapide de l'élément
- 3 Trémie en plastique - 34 l
- 4 Réglage de la profondeur du semis: précise et linéaire
- 5 Sélecteur de graine en acier inoxydable
- 6 Roue arrière de compression (Farmflex, en caoutchouc Ø 370, en caoutchouc en V de 2", en caoutchouc en V de 1")
- 7 Éléments couvre-sillon pour assurer la fermeture du sillon de semis.
- 8 Corps distributeur entièrement en aluminium
- 9 Soc en acier avec remplacement rapide
- 10 Écarteur de mottes réglable
- 11 Fiable transmission à cardan avec débrayage rapide et sécurité acoustique: aucun entretien
- 12 Douilles frittées autolubrifiantes: aucun entretien
- 13 Ouverture rapide pour un remplacement rapide du disque, joint à faible frottement



## CARATTERISTICHE - FEATURES - FONCTIONS

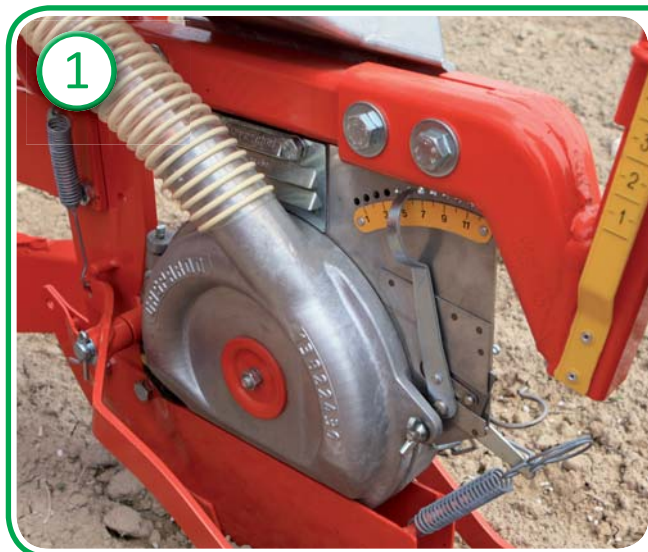

- ① Distributore con doppio selettore seme (nella foto colorato in rosso)
- ② Regolazione profondità di semina
- ③ Cardano: trasmissione precisa, affidabile e non necessita lubrificazione e manutenzione
- ④ Accessorio: ruote di trasmissione regolabili per semina su letti rialzati



- ① Distributor with double seed selector (red in the image)
- ② Seeding depth adjustment
- ③ PTO shaft: precise transmission, reliable and requires no lubrication and maintenance
- ④ Optional: adjustable transmission wheels allows seeding on raised beds



- ① Distributeur avec double sélecteur (rouge)
- ② Réglage de la profondeur du semis
- ③ Cardan: transmission précise, fiable et ne nécessite pas de lubrification et d'entretien
- ④ Optional: roues de transmission réglables permet semis sur lits rehaussés

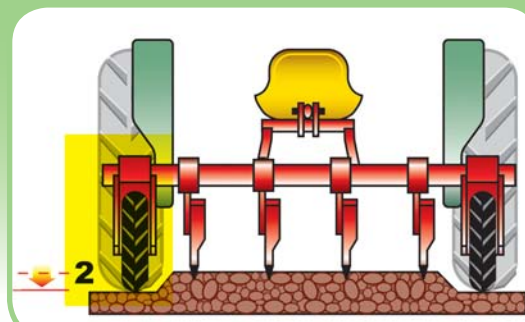
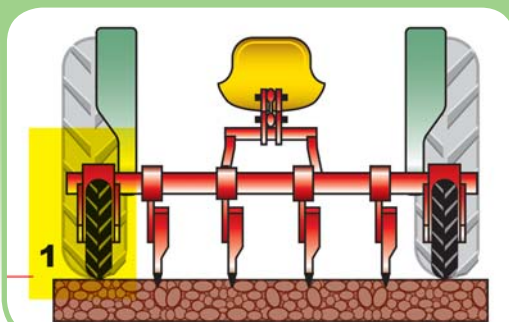
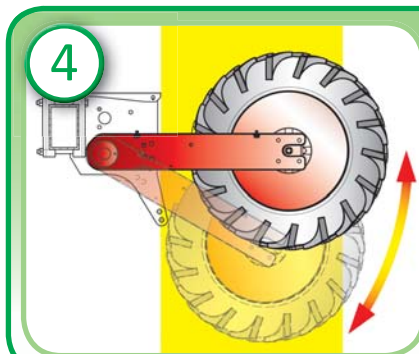

## CONFIGURAZIONI DELL'ELEMENTO SEMINATORE - SEEDING ASSEMBLY CONFIGURATIONS CONFIGURATIONS DE L'ÉLÉMENT SEMEUR

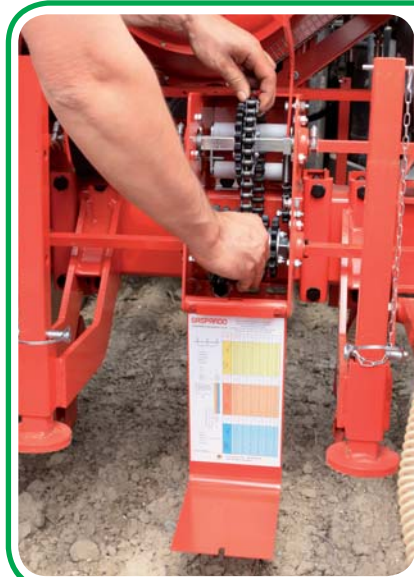

Molteplici sono le configurazioni possibili che consentono di adattare l'elemento seminatore ai diversi terreni e semine. Cambio ad ingranaggi per una semplice e veloce configurazione.



Various configurations are available to adapt the seeding units to different soils and crops. Mechanical gear shift for quick and easy configuration.



Nombreuses possibilités de configuration pour adapter l'élément semeur aux différents types de sols et de semis. Boîte à engrenages pour un changement de configuration simple et rapide.

## RUOTE COPRISEME - PRESS WHEEL - ROUES DE COUVREMENT



## SPEEDY SET



M  
I  
N  
I  
M  
A  
X

## SPANDICONCIME

FERTILIZER - FERTILISEUR



Il distributore volumetrico **MINIMAX** è facilmente regolabile e consente la distribuzione di fertilizzante a diversi dosaggi mantenendo elevata la precisione distributiva: 50-700 kg/ha.

**Regolazione centralizzata, comoda e veloce - SPEEDY SET!**



The **MINIMAX** volumetric distributor is easy to adjust and distributes fertilizer at the required doses with accurate rates: 50-700 kg/ha.

**Quick, easy and central adjustment system - SPEEDY SET!**



Le distributeur volumétrique **MINIMAX** est facile à régler et permet de distribuer le fertilisant à différents dosages tout en maintenant la précision de distribution : 50-700 kg/ha.

**Réglage centralisée, rapide et pratique - SPEEDY SET!**



Il distributore volumetrico **SOFT FEEDER** dosa con continuità il prodotto senza danneggiare il granulato; l'elemento in gomma silconica e il corpo in plastica sono garanzia di durata elevata e resistenza alla corrosione.



The volumetric doser **SOFT FEEDER** feeds continuously the fertilizer without damages for grains; the element made by silconic rubber and the plastic body are guarantee of maximum durability and corrosion resistance.



Le distributeur volumétrique **SOFT SEEDER** distribue en continuité le produit sans le endommager; l'élément en silconai et le corps en plastique sont garantie de longue durabilité et résistance à la corrosion.

## MICROGRANULATORE

MICROGRANULATOR - DISTRIBUTEUR DE MICROGRANULÉS



Microdistributore: applicabile a richiesta per la distribuzione di concimi o geodisinfestanti microgranulari.



Microgranulator: installed on request for distributing microdoses of soil seedkillers.



Distributeur de microgranulés: installable sur demande pour la distribution d'engrais ou de produits insecticides en micro-doses.

## ASSOLCATORI

COULTERS - SOCS



A seconda dei modelli e delle esigenze agronomiche si può scegliere di **localizzare il concime con assolcatore a stivaletto o doppio disco** o tramite depressore **direttamente nel solco di semina.**



Depending on the seeder version and on **crop requirements**, fertilizer can be placed using the **boot coulter, the double-disc coulter** or applying the presser **directly inside the seeding furrow.**



En fonction des modèles et des **exigences agronomiques**, il est possible de **placer l'engrais à l'aide d'un soc ou d'un double disque** ou bien à l'aide d'un système à aspiration **directement dans le sillon de semis.**

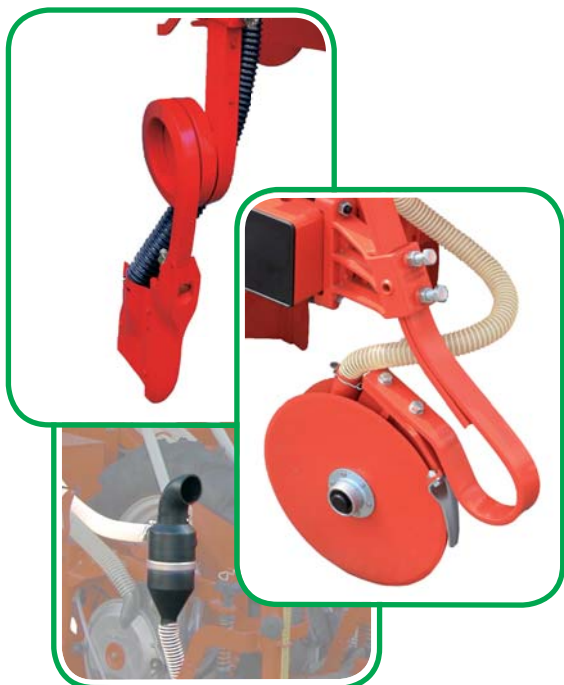

## TRAMOGGIA ANTERIORE - FRONT HOPPER - TRÉMIE AVANT

Il dosatore volumetrico GASPARDO abbinato ad un motore elettrico **gestito dalla centralina GENIUS** consente la distribuzione di quantitativi di fertilizzante tra i **40 e 400 kg/ha**.

VANTAGGI:

- Distribuzione del fertilizzante omogenea, **senza ritardi alla partenza e accumuli a fine campo**
- Possibilità di **variare la quantità di fertilizzante erogata anche in corsa tramite GENIUS**
- Elevata **resistenza alla corrosione** dell'intero gruppo distributore
- Grande diametro del rullo dosatore per ridurre il numero di giri ed evitare perdite di carico
- Numero elevato di celle disposte in maniera sfalsata per garantire **un dosaggio costante**
- Costruzione interna senza punti di attrito, per ridurre al minimo lo sforzo
- **Rapido svuotamento e facile pulizia**



Tramoggia frontale PA1 • PA1 Front hopper •  
Trémie frontale PA1



GENIUS

Dosatore azionamento elettrico • Electric dosing unit • Doseur à actionnement électrique

The GASPARDO volumetric doser, coupled with an electric motor **controlled by the GENIUS unit**, can distribute fertilizer at rates varying between **40 and 400 kg/ha**.

ADVANTAGES:

- Uniform distribution of fertilizer, **without delays at the start or pile-ups at the end of the field**
- **Fertilizer quantities can be changed during operation by the GENIUS control unit**
- The entire distributor assembly is **highly corrosion resistant**
- Large-diameter dosing roller to reduce the rpm and prevent spilling the load
- Large number of staggered cells to ensure **consistent dosing at all times**
- Internal construction with no points of friction to minimize strain
- **Fast to empty and easy to clean**

Le doseur volumétrique GASPARDO, associé à un moteur électrique **géré par une centrale GENIUS**, permet la distribution de quantités de fertilisant variant entre **40 et 400 kg/ha**.

AVANTAGES:

- Distribution homogène du fertilisant, **sans retard au départ ni accumulation en fin de champ**
- **Possibilité de varier la quantité de fertilisant distribuée également en phase de travail à l'aide de GENIUS**
- **Résistance élevée à la corrosion** de tout le groupe de distribution
- Grand diamètre du rouleau doseur pour réduire le nombre de tours et éviter les pertes de charge
- Nombre important de cellules disposées en décalé pour **assurer un dosage constant**
- Construction interne sans points de frottement afin de réduire au minimum l'effort
- **Vidage rapide et nettoyage simple**



## HCS

- Conteggio parziale e totale della superficie lavorata
- Partial and total count of worked area
- Calcul partiel ou total de la surface semée



## V800

- Contaettari
- Allarme controllo semina per fila
- Hectare counter
- Row seeding control alarm
- Compteur d'hectares
- Alarme contrôle semis par rangée



## MCE 6000/12000

- Allarme controllo semina per fila
- Densità di semina (numero di semi per m<sup>2</sup>)
- Area lavorata parziale e totale (ha)
- Distanza di semina (cm) media di tutte le file oppure di ogni singola fila attiva
- Predisposto per accessorio esclusione file\*
- Row seeding control alarm
- Seeding density (number of seeds per m<sup>2</sup>)
- Partial and total worked area (ha)
- Average seeding distance (cm) for all rows or actual value for current row
- Preset for mounting row-bypass accessory\*
- Alarme contrôle semis par rangée
- Densité de semis (nombre de graines par m<sup>2</sup>)
- Zone semée partielle et totale (ha)
- Distance de semis moyenne (cm) de toutes les rangées ou de chaque rangée active
- Prévu pour accessoire d'exclusion de rangées\*

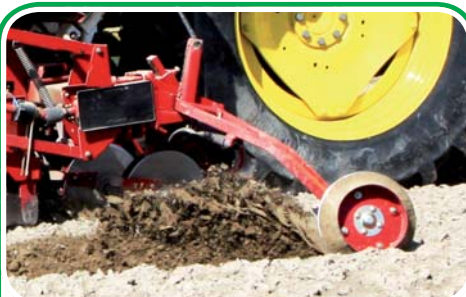

- Segnafile automatico a scatto traccia su ruota (opzionale idraulico e/o traccia al centro)
- Semi-automatic marker row on center wheel (optional hydraulic and/or center track)
- Traceur semi-automatique trace sur roue (hydraulique optionel et/ou traçage au centre)

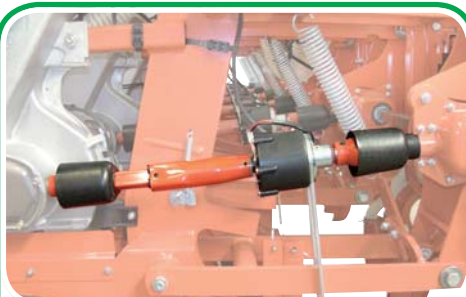

- \*Esclusione elettrica fila
- \*Electric row shut-off
- \*Exclusion fichier électronique





- Vernice anti corrosione ad alta resistenza, trattamento di cataforesi sulle componenti metalliche
- High-resistance anti-corrosion paint applied by cataphoresis on metal parts
- Peinture anticorrosion haute résistance, traitement par cataphorèse des composante métalliques





# SP DORADA

## TELAIO FISSO - FIXED FRAME - CHÂSSIS FIXE

-  Il modello **SP DORADA** nella versione Mais e Bietola è caratterizzato da un telaio fisso di larghezza variabile a seconda del numero di file e dell'interfila scelto.
-  The **SP DORADA** model in the corn and beet version is equipped with a fixed frame having variable width depending on the required number of rows and the row width.
-  Les modèles **SP DORADA** versions Maïs et Betterave présentent un châssis fixe de largeur variable en fonction du nombre de rangées et de la distance entre les rangées.



### SP DORADA

N. file - Rows - N° rangées		4	5	6	8	12
Larghezza telaio - Frame width - Largeur châssis	cm / inch	250 / 98	320 / 125	250 / 98	420 / 165	580 / 228
Distanza interfila - Row width - Distance entre les rangées	cm / inch	75 / 29	75 / 29	45 / 17	45 / 17	45 / 17
Potenza richiesta - Power required - Puissance requise	hp / kW	60 / 44	70 / 52	70 / 52	90 / 67	100 / 74
Capacità serbatoio concime - Fertilizer tank capacity - Capacité réservoir d'engrais	n x l.	2x160	2x160	2x160 / 2x280	2x280 / 4x160	4x160
Peso - Weight - Poids	kg / lb	690 / 1521	770 / 1697	845 / 875 / 1862 / 1929	1085 / 1095 / 2392 / 2414	1226 / 2702

## TELAIO TELESCOPICO - TELESOPING FRAME - CHÂSSIS TÉLESCOPIQUE



Il modello **SARA** è dedicato alla semina del Mais, il telaio è telescopico in due sezioni **con chiusura a 2,5 m** e 6 elementi seminatori a 75 cm. Può essere dotato di spandiconcime con serbatoio in acciaio INOX e assolcatore a stivaletto e/o di microgranulatore.



The **SARA** model, designed for sowing corn, is equipped with a double telescoping frame that **closes down to 2.5 m** and has 6 seeding units placed at 75 cm. It can be fitted with a fertilizer distributor with stainless steel tank and a boot drill and/or microgranulator.



Le modèle **SARA** est spécialement conçu pour semer le Maïs. Le châssis double télescopique a un encombrement **de 2,5 m fermé** et compte 6 éléments semeurs à 75 cm de distance. Il peut être équipé d'un épandeur avec réservoir en acier INOX, soc et/ou distributeur de microgranulés.

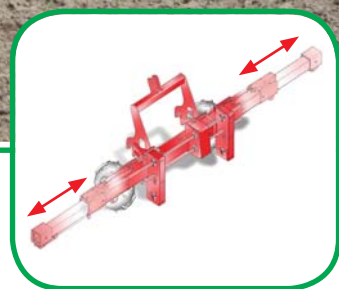

### SARA

N. file - Rows - N° rangées		6
Larghezza telaio - Frame width - Largeur châssis	cm / inch	400 / 157
Distanza interfila - Row width - Distance entre les rangées	cm / inch	75 / 29
Potenza richiesta - Power required - Puissance requise	hp / kW	90 / 67
Capacità serbatoio concime - Fertilizer tank capacity - Capacité réservoir d'engrais	n x l.	1x650
Peso - Weight - Poids	kg / lb	1150 / 2535

# ST STELLA

## TELAIO TELESCOPICO - TELESOPING FRAME - CHÂSSIS TÉLESCOPIQUE



Il modello **ST STELLA** è dedicato alla semina del Mais, il telaio è telescopico con **chiusura a 3 m**. Può essere dotato di spandiconcime con serbatoio in plastica o nella versione Big Bag con tramoggia in metallo con capacità 1000 l e trasporto pneumatico sulle file esterne.



The **ST STELLA** model, designed for sowing corn, is equipped with a telescoping frame that **closes down to 3 m**. It can be fitted with a fertilizer distributor with plastic tank or, in the Big Bag version, with a metal hopper having a capacity of 1000 l and pneumatic carriage on the external rows.



Le modèle **ST STELLA** est spécialement conçu pour semer le Maïs. Le châssis télescopique a un encombrement **de 3 m fermé**. Il peut être équipé d'un épandeur avec réservoir en plastique ou en version Big Bag avec trémie en métal d'une capacité de 1000 l et transport pneumatique sur les rangées externes.





## ST STELLA



N. file - Rows - N° rangées		6	7	8
Larghezza telaio - Frame width - Largeur châssis	cm / inch	400 / 157	400 / 157	400 / 157
Distanza interfila - Row width - Distance entre les rangées	cm / inch	75 / 29	60 / 23	45 / 17
Potenza richiesta - Power required - Puissance requise	hp / kW	80 / 59	90 / 67	90 / 67
Capacità serbatoio concime - Fertilizer tank capacity - Capacité réservoir d'engrais	n x l.	2x200 / 1x1000	2x200	2x200
Peso - Weight - Poids	kg / lb	1170 / 1270 / 2579 / 2799	1250 / 2755	1320 / 2910

## TELAIO PIEGHEVOLE - FOLDING FRAME - CHÂSSIS PLIANT

-  Il modello **SI SIMONA** nelle versioni Mais e Bietola si caratterizza per il telaio pieghevole con chiusura di trasporto a 3 m. È dotato di un sistema di compensazione dell'impianto idraulico sulle ali laterali, per adattarsi a terreni non pianeggianti.
-  The **SI SIMONA** model in the corn and beet versions is equipped with a folding frame that closes down to 3 m for transportation. This model is provided with a hydraulic compensation system on the wings for better adapting to non-level ground.
-  Le modèle **SI SIMONA**, dans les versions Maïs et Betterave, a un châssis pliant présentant un encombrement de transport de 3 m. Il est équipé d'un système de compensation de l'installation hydraulique sur les ailes latérales afin de s'adapter aux sols irréguliers.

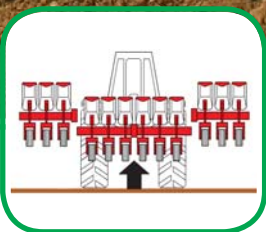
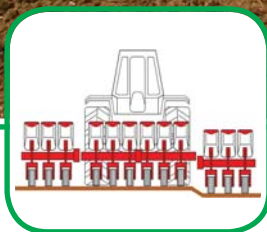

### SI SIMONA



N. file - Rows - N° rangées

8

12

Larghezza telaio - Frame width - Largeur châssis

cm / inch

560 / 220

560 / 220

Distanza interfila - Row width - Distance entre les rangées

cm / inch

75 / 29

45 / 17

Potenza richiesta - Power required - Puissance requise

hp / kW

100 / 74

120 / 89

Capacità serbatoio concime - Fertilizer tank capacity - Capacité réservoir d'engrais

n x l.

4x160

PA1 1260

Peso - Weight - Poids

kg  
lb

2100  
4629

2225  
4905

# SILVIA

## TELAIO PIEGHEVOLE E TELESCOPICO - FOLDING AND TELESCOPING FRAME CHÂSSIS PLIANT ET TÉLESCOPIQUE



Il modello **SILVIA** è caratterizzato dal telaio pieghevole in 3 sezioni con sezioni telescopiche dotate di 12 elementi a 70 o 75 cm, è indicato per la semina di mais, girasole e soia. L'ingombro per il trasporto su strada è di 3.30 m. È possibile applicare la tramoggia anteriore per la distribuzione del concime (PA1) con assolcatore a doppio disco. Il telaio consente un'aderenza costante degli elementi anche su terreni non pianeggianti.



The **SILVIA** model is equipped with a 3-part folding frame with 3 telescoping sections provided with 12 segments placed at 70 or 75 cm. This model can be used for sowing corn, sunflower and soybean crops. The machine can be closed down to 3.30 m for transportation on road. It can be fitted with a hopper on the front for distributing fertilizer (PA1) with a double-disc drill. The frame is designed to keep the units firmly on the ground even when working on non-level ground.



Le modèle **SILVIA** présente un châssis pliable en 3 parties et des sections télescopiques à 12 éléments espacés de 70 ou 75 cm. Particulièrement indiqué pour semer le maïs, le tournesol et le soja. Son encombrement sur route est de 3,30 m. Il est possible d'installer une trémie à l'avant pour l'épandage de l'engrais (PA1) avec soc à double disque. Le châssis procure une adhérence constante des éléments également sur les sols irréguliers.

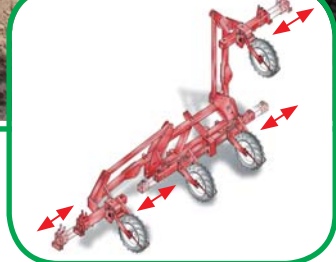
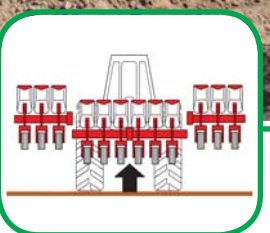
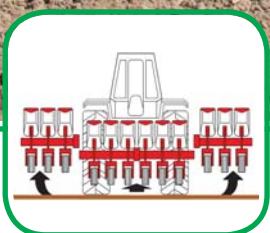
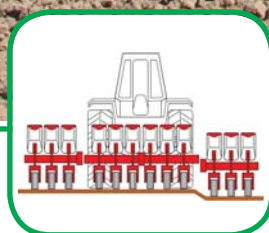

### SILVIA



N. file - Rows - N° rangées

12

12

Larghezza telaio - Frame width - Largeur châssis

cm / inch

975 / 383

975 / 383

Distanza interfila - Row width - Distance entre les rangées

cm / inch

75 / 29

70 / 27,5

Potenza richiesta - Power required - Puissance requise

hp / kW

120 / 89

120 / 89

Capacità serbatoio concime - Fertilizer tank capacity - Capacité réservoir d'engrais

n x l.

PA1 1260

PA1 1260

Peso - Weight - Poids

kg  
lb

2135  
4706

2135  
4706

## PRINCIPALI ACCESSORI - MAIN ACCESSORIES - PRINCIPAUX ACCESSOIRES



Coclea di carico concime • Fertilizer loading auger • Vis sans fin de chargement de l'engrais



Doppio disco per terreni con residui culturali  
• Double disc opener for mulch condition • Enfouisseur double disque pour terrains avec résidus culturaux

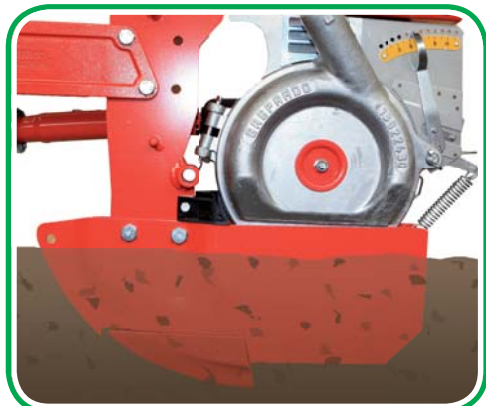

Falcione semina profonda • Deep planting coulter • Soc pour semis en profondeur

Rompitraccia 4 pezzi • 4 wheel track removers • Effaceur de traces 4 pièces

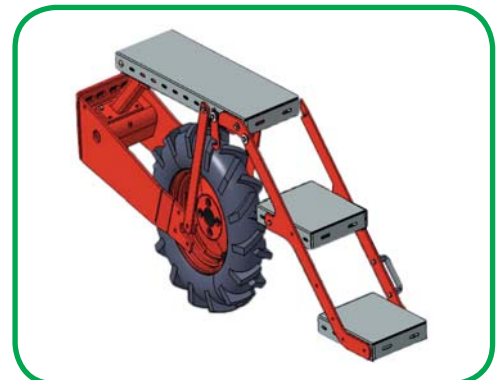

Scaletta per ispezione spandiconcime • Fertilizer distributor inspection steps • Échelle pour contrôle épandeur



Espulsore seme • Seed knocker for coated seed • Ejecteur graine



Kit applicazione doppio micro per trattamenti vari 2 file • Double microdistributor kit for working on 2 rows • Kit application double micro pour traitements divers 2 rangées



Kit presa di forza 1000 giri • 1000 rpm PTO kit • Kit prise de mouvement 1000 tr/mn



Tabelle d'ingombro • Warning signs • Tableaux encombrements



Azionamento soffiante idraulico • Hydraulic blower • Actionnement soufflante hydraulique



Carrello di trasporto • Transportation trailer • Chariot de transport

## DISCHI DI SEMINA - SEEDING DISCS - DISQUES DE SEMIS

Nr°	Ø	Coltura	Seeds	Cultures	Distanza di semina Seeding distance Distance de semis
20	2,5	Girasole	Sunflower	Tournesol	↓ min. 10,4 cm. ↑ max. 41,7 cm.
20	3,5	Cotone - Mais (piccolo)	Cotton - Corn (Little)	- Mais (Petit)	
20	5,5	Mais (Grosso) - Ceci - Fagiolo borlotto e cannellino - Arachidi	Corn (Big) - Pulses - Beans - Peanut	Mais (Gros) - - Haricot -	
20	7	Arachidi - Lupino	Peanut -	- -	
26	2,5	Girasole	Sunflower	Tournesol	↓ min. 8 cm. ↑ max. 32,1 cm.
26	3,5	Cotone - Mais (Piccolo)	Cotton - Corn (Little)	- Mais (Petit)	
26	4,5	Mais	Corn	Mais	
36	1	Pomodoro	Tomato	Tomate	
36	1,5	Lenticchia - Cetriolo - Pomodoro conf. Ø 2,5÷3,5 mm	- Cucumber - Tomato pilled Ø 2,5 ÷ 3,5 mm	- Concombre - Tomate enrob Ø 2,5 ÷ 3,5 mm	↓ min. 5,8 cm. ↑ max. 23,2 cm.
36	2,1	Barbabietola - Zucchini - Melone - Anguria - Cardo - Sorgo - Sesamo	Beets - Squash - Melon - Watermelon - - Sorghum -	Betteraves - Courgette - Melon - Past que - - Sorgo -	
36	2,5	Pomodoro conf. Ø 3,5÷4,5 mm - Ginseng	Tomato pilled Ø 3,5÷4,5 mm - Ginseng	Tomate enrob Ø 3,5÷4,5 mm - Ginseng	
36	3,5	Fagiolino - Piselli - Soia	Beans (little) - Peas - Soyabeans	Haricot (Petit) - Pois - Soja	
36	4,5	Fagiolo - Piselli - Favino	Beans - Peas -	Haricot - Pois -	↑ min. 4 cm. ↓ max. 16 cm.
36	5,5	Fagiolo	Beans	Haricot	
52	4,25	Soia	Soyabeans	Soja	↓ min. 2,9 cm. ↑ max. 11,6 cm.
72	2,1	Bieta a coste - Saggina	Swiss Chard -	Poir -	
72	3,5	Fagiolino - Soia	Beans (Little) - Soyabeans	Haricot (Petit) - Soja	

**MASCHIO GASPARDO**

*insieme si vince*

**MASCHIO GASPARDO S.p.A.**

Registered Office  
Via Marcellò, 73  
35011 Campodarsego - Padova - Italy  
Tel. +39 049 9289810 - Fax +39 049 9289900

e-mail: info@maschio.it  
http://www.maschionet.com

Production plant  
Via Mussons, 7  
I - 33075 Morsano al Tagliamento (PN) Italy  
Tel. +39 0434 695410 - Fax +39 0434 695425



**MASCHIO FRANCE S.a.r.l.**

1, rue de Merignan ZA  
F - 45240 LA FERTE SAINT AUBIN - France  
Tel. +33 (0) 2.38.64.12.12  
Fax +33 (0) 2.38.64.66.79

**MASCHIO-GASPARDO North America, Inc.**

120 North Scott Park Road  
Eldridge, IA 52748  
Phone: (888) 648-7462  
Fax: (563) 285-9938

DEALER: